





Sheen™ Low Profile Light

INSTALLATION INSTRUCTIONS

Part#: 7003B-FF-KK

PARTS/TOOLS NEEDED:			
			
Sheen™ Low Profile Light	Two #8 Pan head screws (Not Provided)	Protective Grommet (Not Provided)	Power Drill

IMPORTANT SAFETY INSTRUCTIONS. READ CAREFULLY FOR YOUR PROTECTION AND SAVE ALL INSTRUCTIONS.

- Disconnect power before installing, adding or changing any component.
- To avoid a hazard to children, account for all parts and destroy all packing materials.
- It is recommended that fuse protection be added to the positive (+) input.

1. Ensure the intended area for mounting is large enough to fit the light and bezel per the dimensions shown in figure 1.

**Ensure the area behind the light is sealed location.*

Figure 1

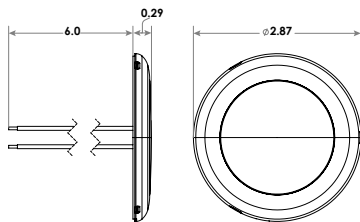

2. The wire exit is centered in the light. First mark the location on the mounting surface for wire entry. A 3/8" diameter hole is recommended for wire entry. If mounting to a metal ceiling material, ITC recommends using a protective grommet to protect the wires from cutting or fraying over time. Hole size may need to be larger depending on use of grommet.
3. Place light over wire entry hole and use the mounting screw holes as a template to mark the locations of the 2 screw locations. ITC recommends a #8 Pan head screw for mounting.
4. Make wire connections to vehicle wiring system using the diagram.

See wiring diagram

Wiring Diagram

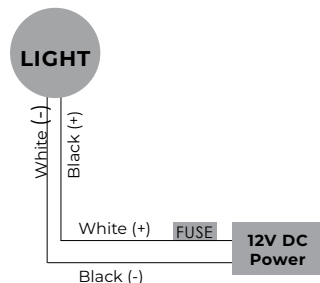

5. Secure light to ceiling using customer supplied #8 pan head screws

See figure 2

Figure 2

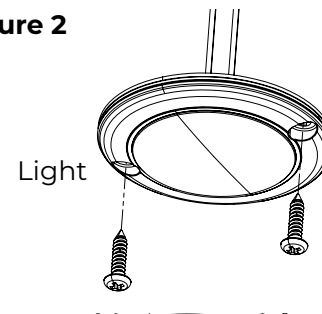

6. Snap the bezel into the mounted light assembly. Ensure all snaps have fully engaged to secure bezel to the light.

See figure 3

Figure 3

