





LOOK BACKLIT MIRROR

INSTALLATION INSTRUCTIONS

Part#: 69455.ELS.XXXX.YYK.RMT & .EU
 69455.XXXX.YYK.RMT & .EU
 694XXWVHH-KKLLLOOM

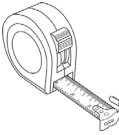
PARTS/TOOLS NEEDED:

		Power Supply		
Backlit Mirror (Style varies)	Mounting Hardware	Purchased Separately	Tape Measure	Electric Drill

IMPORTANT SAFETY INSTRUCTIONS - SAVE THESE INSTRUCTIONS

Read all instructions before using this mirror.

MIRRORS SHOULD ONLY BE INSTALLED USING THE FOLLOWING INSTRUCTIONS. FAILURE TO FOLLOW THESE INSTRUCTIONS WILL VOID THE WARRANTY.

WARNING - To reduce the risk of burns, fire, electric shock, or injury to persons:

- Unplug power before putting on or taking off parts.
- Close supervision is necessary when this mirror is used by, or near children, invalids, or disabled persons.
- Use this mirror only for its intended use as described in these instructions. Do not use attachments not recommended by ITC Architectural
- Never operate this mirror if it has a damaged cord, if it is not working properly, if it has been dropped or damaged, or dropped into water. Contact ITC Architectural for a replacement mirror.
- Keep the cord away from heated surfaces.
- Never drop or insert any object into any opening.
- Do not use outdoors.
- Exposing the mirror edges to liquids may cause a permanent discoloration to the mirror etching that is NOT covered by ITC warranty.
- **WARNING:** Risk of electric shock - Connect this mirror to a properly grounded outlet only. See grounding instructions.

CLEANING INSTRUCTIONS

- Clean mirrors with warm water and a soft, lint free cloth, do not allow liquids to seep under the edges. Don't use abrasive, acid or alkali cleaners or products with ammonia or vinegar.
- Apply mild cleaners directly to a cloth, do not spray directly on the mirror. Applying liquids directly to the mirror's surface may allow the liquid to seep/wick between the layers on the edge of the mirror. If this occurs there may be a permanent discoloration on the mirror etching which is NOT covered by ITC warranty.
- Dry mirror immediately following cleaning and make sure all joints and edges are dry.

1. Mark the location of the mounting holes. See individual product specifications for mounting hole locations.

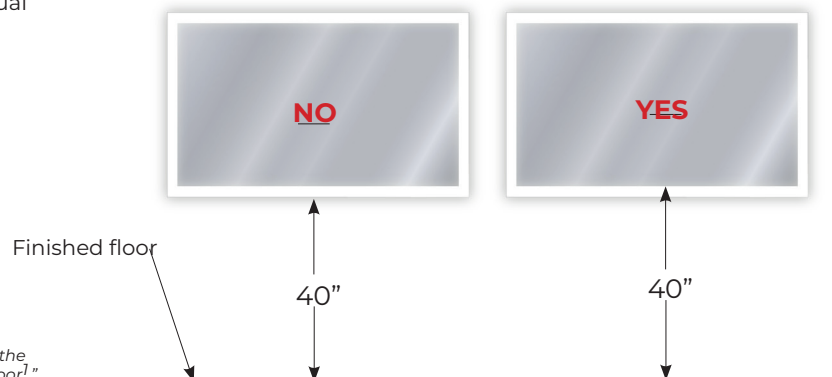

ADA requires that "Mirrors shall be mounted with the bottom edge of the reflecting surface no higher than 40 in (1015mm) above the finished floor¹." For lit mirrors this means the dimension is to the inner most edge of the lit portion.



3030 Corporate Grove Dr.
 Hudsonville, MI 49426
 Phone: 616.396.1355
itc-us.com

For warranty information please visit www.itc-us.com/warranty-return-policy
 DOC #: 710-00009 · Rev L · 10/11/22

2. Install included #14 round slotted wood mounting screws into pre-marked holes. Note, all mirrors must be installed in contractor supplied blocking.
Slide the mirror assembly onto the screws.

Ensure screw sits all the way at the top of the keyhole slot

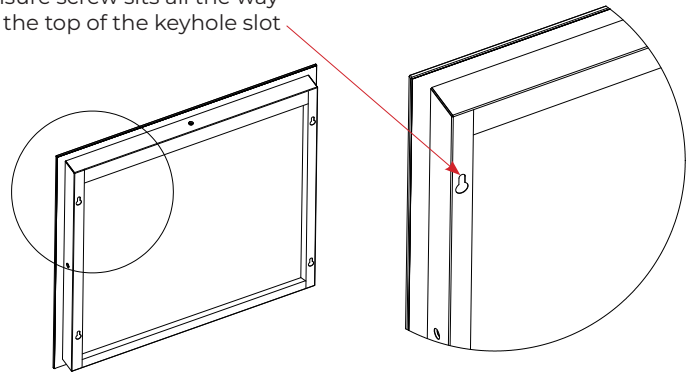

3. TROUBLESHOOTING

The mirror doesn't light:

- A. Check the connection between the mirror and buildings wiring.
- B. Verify that there is power coming out of the power supply.
- C. Verify that there is 120V power coming out of the buildings junction box.
- D. Verify that the tape light has not been unplugged from the power supply.

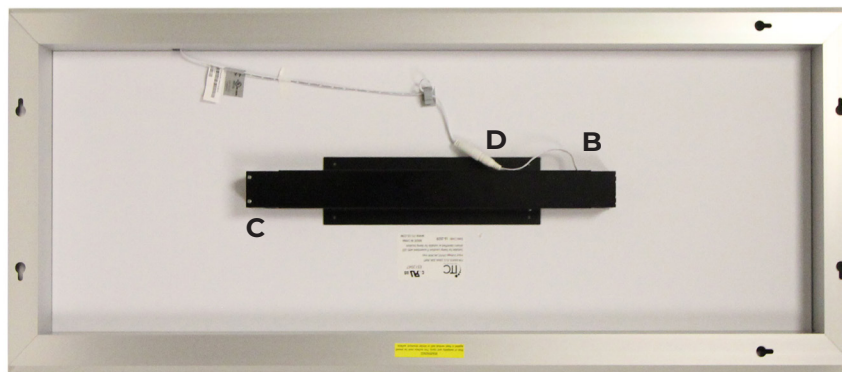

Part of the mirror won't light:

- E. This is mostly likely due to a bad LED, however, follow the previous steps to make sure all connections are done correctly.

Note: The above mirror image is to be used for reference only, see dimensional drawings for each individual mirror for details on size, power supply placement, key hole slots, etc.

